

Intercalation reactions of krautite, $\text{HMnAsO}_4 \cdot \text{H}_2\text{O}$

A. M. BUCKLEY,* S. T. BRAMWELL,** P. DAY**

Inorganic Chemistry Laboratory, Oxford University, South Parks Road, Oxford OX1 3QR, England

ABSTRACT

The mineral krautite ($\text{MnHAsO}_4 \cdot \text{H}_2\text{O}$) has acidic layers and intercalates alkylamines directly by an acid-base reaction. Intercalation causes expansion of the lattice in the *b* direction only with a corresponding increase in basal spacing. For alkyl chains of three to eight C, ordered aggregates of alkylammonium ions are formed, which are arranged in bilayers and tilted at $\sim 64^\circ$ to the basal plane. An odd-even alternation in basal spacing indicates that the N-C₁ bond is almost normal to the basal plane and H bonding between two or more H atoms of NH_3 and surface O may occur. For alkylammonium ions containing more than eight C, the cations appear to form kink structures in which the alkyl chains are bent. Interstratified structures are also discussed.

INTRODUCTION

The compound $\text{HMnAsO}_4 \cdot \text{H}_2\text{O}$, a rare layered mineral called krautite, is known to occur in Transylvania, Romania. It was first characterized as a new mineral by Fontan et al. (1975), who also established the unit cell as monoclinic ($a = 8.00$, $b = 15.93$, $c = 6.79$ Å, and $\beta = 96^\circ 32'$). Catti and Franchini-Angela (1979) solved the crystal structure of krautite by single-crystal X-ray methods and confirmed the unit cell proposed by Fontan et al. The space group was found to be $P2_1$, with the structure being built up of sheets parallel to (010), within which AsO_4 and MnO_6 polyhedra share edges to form [101] chains. Recent high-resolution powder neutron diffraction measurements on $\text{DMnAsO}_4 \cdot \text{D}_2\text{O}$ (Buckley et al., unpublished data) confirmed this structure and allowed the positions of the deuterium atoms to be located. The structures of other hydrated arsenates, e.g., $\text{CaHAsO}_4 \cdot \text{H}_2\text{O}$ (Ferraris et al., 1972), $\text{CaHAsO}_4 \cdot 2\text{H}_2\text{O}$ (Ferraris, 1969), $\text{CaMn}(\text{HAsO}_4)_2 \cdot 2\text{H}_2\text{O}$ (Catti et al., 1980), and $\text{CoHAsO}_4 \cdot \text{H}_2\text{O}$ (Zettler et al., 1979) are all closely related to that of krautite by virtue of having similar layer structures.

Beneke and Lagaly (1981) investigated the intercalation reactions between krautite and various neutral molecules. They found that basic molecules, such as alkylamines, expand the structure in the [010] direction, whereas molecules with high dipole moments such as urea or DMSO would not react. Krautite and its intercalated derivatives with alkylamines have also been shown to be interesting examples of two-dimensional antiferromagnets (Bramwell et al., 1988; Buckley, 1988).

In this paper we extend the results obtained by Beneke

and Lagaly and describe the preparation and characterization of alkylamine derivatives of krautite, $\text{C}_n\text{-H}_{2n+1}\text{NH}_2\text{MnHAsO}_4 \cdot \text{H}_2\text{O}$ ($n = 1-10$). These relations lead to an interpretation of the interlayer structures different from that proposed by Beneke and Lagaly.

EXPERIMENTAL

The method of Catti and Franchini-Angela (1979) was used to prepare well-crystallized samples of synthetic krautite. A total of 4.5 g (0.025 mol) of KH_2AsO_4 and 4.95 g (0.025 mol) of $\text{MnCl}_2 \cdot 4\text{H}_2\text{O}$ were each dissolved in about 20 mL of distilled H_2O . The arsenate sample required warming for complete dissolution. Both solutions were then simultaneously poured into the same conical flask, forming a transparent gel. The flask was covered and left for about six weeks. After this period, the gel disintegrated, leaving a clear solution and pink crystallites of synthetic krautite. The liquid was then removed by filtration, and the crystals were dried in air.

Intercalated derivatives of synthetic krautite, $\text{C}_n\text{-H}_{2n+1}\text{NH}_3\text{MnAsO}_4 \cdot \text{H}_2\text{O}$ ($n = 1, 3, 4, 5, 6, 7, 8, 9, 10$) were prepared by treating about 1 g of synthetic krautite with approximately 2 mL of ethanol and 3 mL of the required alkylamine (Beneke and Lagaly, 1981). The suspension was vigorously stirred and refluxed at about 65°C for 24 h. After this time, the suspension was filtered and analyzed for the degree of reaction and, if required, a new solution of the alkylamine in ethanol was added.

Samples of synthetic krautite and its intercalated derivatives were characterized using chemical analysis, scanning electron microscopy (SEM), and powder X-ray diffraction. Chemical analysis was carried out by chromatographic analysis techniques (C, H, N) and by atomic absorption spectroscopy using a Perkin Elmer 8000 Spectrometer (metallic elements). Powder X-ray diffraction profiles were obtained using a Philips PW1729 diffractometer controlled by a Philips 1710 microprocessor and minicomputer. All profiles were recorded using $\text{CuK}\alpha$ ra-

* Present address: Research and Technology, I.C.I. Chemicals and Polymers Ltd., P.O. Box 8, The Heath, Runcorn, Cheshire WA7 4QD, England.

** Present address: Institut Laue-Langevin, 156X, 38042, Grenoble, Cedex, France.



Fig. 1. Scanning electron micrograph of synthetic krautite.

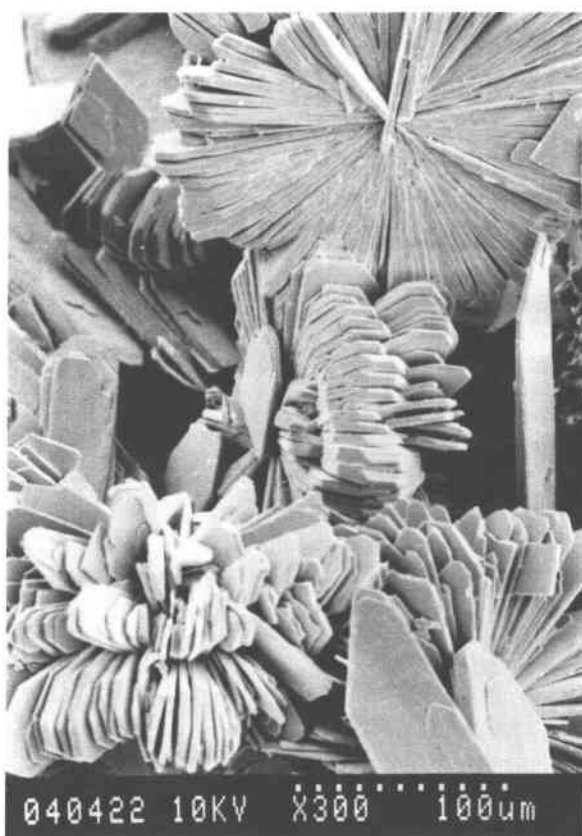

Fig. 2. Scanning electron micrograph of synthetic krautite.

diation of wavelength 1.5418 Å. SEM micrographs were obtained by members of the electron microscopy team in the Characterisation and Measurement Group at I.C.I. Chemicals and Polymers Ltd., Runcorn, using a Hitachi S-650 scanning electron microscope.

RESULTS

Crystal morphology

Figures 1 and 2 show SEM micrographs of synthetic krautite. Each agglomerate consists of rectangular platelets radiating from a central point like spokes to form florets. A single platelet is about 30 μm wide and 60–100 μm long but extremely thin ($<4 \mu\text{m}$). Figures 3 and 4 indicate that intercalation causes the crystallites of krautite to disintegrate when treated with alkylamines, with a resulting reduction in particle size.

Chemical analysis

Chemical analyses of krautite and its intercalates are given in Table 1. The extent of intercalation, x , is calculated from the percentage of N and the percentage of C in the sample. Analyses calculated for complete intercalation are given in parentheses. The sample $R = \text{C}_2\text{H}_5$ could not be prepared.

Power X-ray diffraction

In Figures 5A and 5B, the powder X-ray diffraction profile of krautite is compared to that of a sample of

TABLE 1. Analytical data for $R\text{NH}_2\text{MnHAsO}_4 \cdot \text{H}_2\text{O}$

	$R\text{NH}_2$	% N	% C	% H	% Mn	% As	x
Krautite	—	—	—	—	25.18	35.36	0.00
					(25.87)	(35.19)	
CH_3	1.80	3.30	2.09	19.35	30.65	30.65	0.31
	(5.74)	(4.92)	(3.28)	(22.53)	(30.72)	(30.72)	
C_3H_7	3.93	10.15	3.48	19.80	29.95	29.95	0.76
	(5.15)	(13.24)	(4.41)	(20.23)	(27.55)	(27.55)	
C_4H_9	2.92	10.34	4.07	19.34	28.35	28.35	0.61
	(4.90)	(16.79)	(4.09)	(19.22)	(26.20)	(26.20)	
C_5H_{11}	2.27	10.22	3.57	19.20	26.38	26.38	0.43
	(4.67)	(20.01)	(8.00)	(18.31)	(24.98)	(24.98)	
C_6H_{13}	4.38	22.85	5.29	14.90	25.53	25.53	0.99
	(4.46)	(22.94)	(5.74)	(17.50)	(23.80)	(23.80)	
C_7H_{15}	3.69	22.11	5.18	17.26	24.96	24.96	0.86
	(4.27)	(25.62)	(6.10)	(16.77)	(22.84)	(22.84)	
C_8H_{17}	3.76	25.91	5.86	16.19	23.22	23.22	0.92
	(4.09)	(28.08)	(6.43)	(16.09)	(21.91)	(21.91)	
C_9H_{19}	1.73	13.44	3.92	18.75	28.24	28.24	0.43
	(4.22)	(30.35)	(6.74)	(15.43)	(21.05)	(21.05)	
$\text{C}_{10}\text{H}_{21}$	1.60	13.54	3.95	18.04	28.17	28.17	0.43
	(3.97)	(34.01)	(7.37)	(15.56)	(21.23)	(21.23)	

Note: Analyses calculated for complete intercalation are given in parentheses.

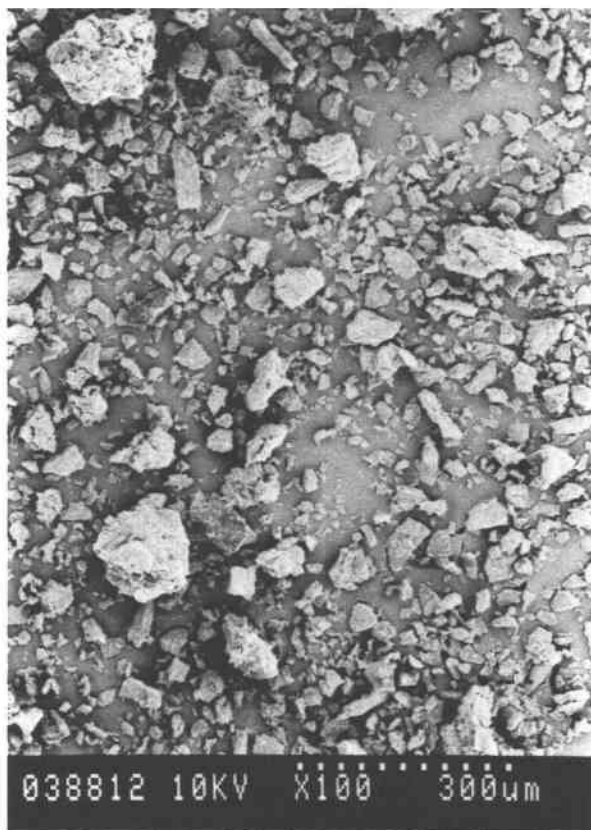

Fig. 3. Scanning electron micrograph of $C_6H_{13}NH_3MnAsO_4 \cdot H_2O$.

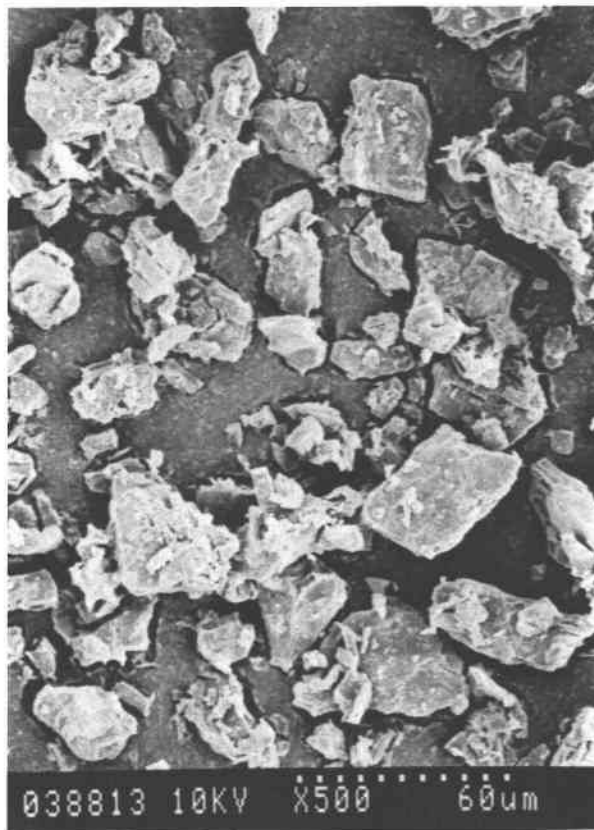

Fig. 4. Scanning electron micrograph of $C_6H_{13}NH_3MnAsO_4 \cdot H_2O$.

synthetic krautite intercalated with $C_7H_{15}NH_2$. The diffraction peaks of the krautite profile may be indexed on a unit cell of dimensions very close to those obtained by Catti and Franchini-Angela (1979) (Table 2). The diffraction profiles of well-reacted samples of krautite (e.g., $N_c = 3, 4, 6, 7, 8$) are characterized by intense basal $0k0$ reflections (where $k = 2n$) usually to about $n = 3$. These are given for each intercalated compound in Table 2. However, the diffraction profiles of the less well-reacted samples of krautite (e.g., $N_c = 1, 5, 9, 10$) exhibit 020 reflections corresponding to a fully reacted portion and

TABLE 2. Lattice parameters and basal spacings (d_{020}) for compounds $RNH_2MnHAsO_4 \cdot H_2O$

<i>R</i>	<i>b</i> (Å)	d_{020} (Å)
Krautite	15.96	7.98
CH_3	20.24	10.12
C_2H_7	34.94	17.47
C_3H_9	35.68	17.84
C_4H_{11}	43.44	21.72
C_6H_{13}	46.40	23.20
C_7H_{15}	52.59	26.30
C_8H_{17}	54.53	27.27
C_9H_{19}	55.04	27.52
$C_{10}H_{21}$	57.96	28.98

the unreacted synthetic krautite (Figs. 5C and 5D). Furthermore, in nearly all cases, additional reflections are observed between the basal reflection from a fully reacted portion and the basal reflection of synthetic krautite.

The relationship between the basal spacing (d_{020}) and the length of C chain of the alkylammonium ion (N_c) is shown in graphic form in Figure 6. A pronounced odd-even alternation between $N_c = 3$ and $N_c = 8$ is observed. Outside these limits the basal spacings do not lie along the straight lines that may be drawn through the data points with $N_c = \text{even}$ and $N_c = \text{odd}$.

The majority of other peaks present in the diffraction profile of synthetic krautite are undetectable in the diffraction profiles of the intercalated compounds, presumably because of considerable particle size broadening.

DISCUSSION

Reactivity

The intercalation of alkylamines ($C_nH_{2n+1}NH_2$) between the manganese arsenate layers of synthetic krautite causes expansion in the *b* direction, with resulting separation of the inorganic layers. The acid-base reaction that occurs may be written as $Mn(H_2O)AsO_3OH + C_nH_{2n+1}NH_2 \rightarrow Mn(H_2O)AsO_4H_3N^+C_nH_{2n+1}$ and is favored

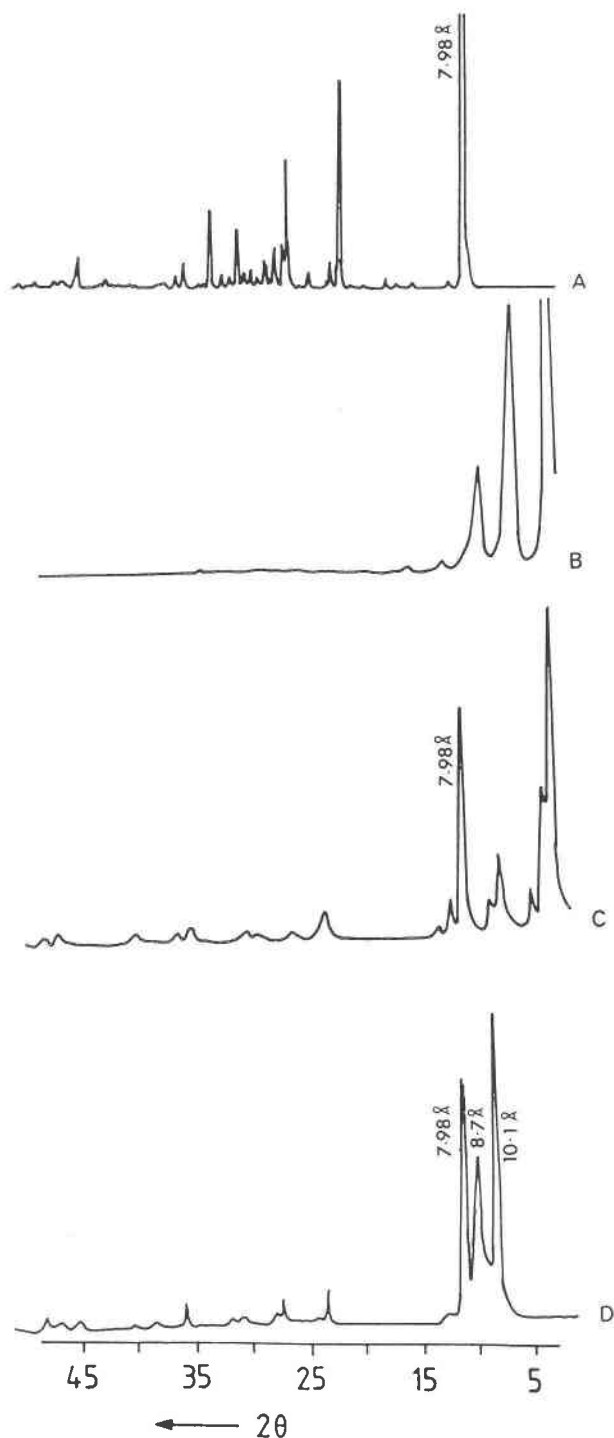

Fig. 5. Powder X-ray diffraction profiles of (A) $\text{HMnAsO}_4 \cdot \text{H}_2\text{O}$, (B) $\text{C}_7\text{H}_{15}\text{NH}_3\text{MnAsO}_4 \cdot \text{H}_2\text{O}$, (C) $\text{C}_3\text{H}_{11}\text{NH}_3\text{MnAsO}_4 \cdot \text{H}_2\text{O}$, and (D) $\text{CH}_3\text{NH}_3\text{MnAsO}_4 \cdot \text{H}_2\text{O}$.

by the fact that the surface acidity ($\text{p}K_s$) of krautite is less than seven (Beneke and Lagaly, 1981). This behavior of krautite toward alkylamines is similar to that of the layered silicic acids such as $\text{H}_2\text{Si}_4\text{O}_9$ and $\text{H}_2\text{Si}_{14}\text{O}_{29} \cdot 5 \cdot 4\text{H}_2\text{O}$,

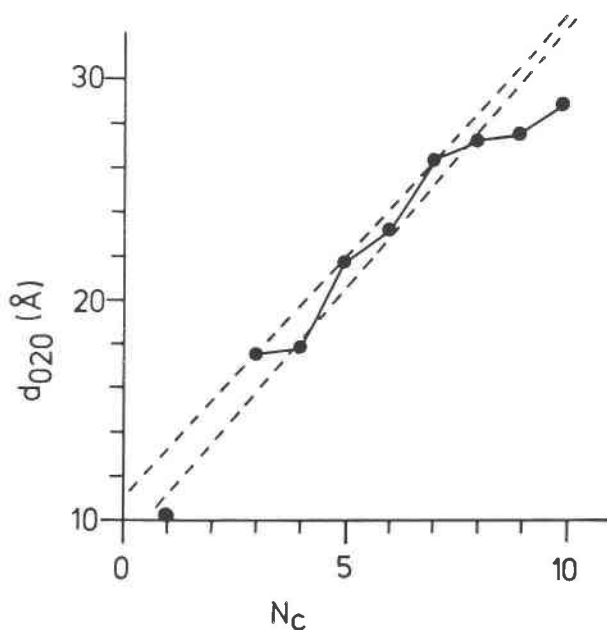

Fig. 6. Basal spacings, d_{020} , of krautite after intercalation of alkylamines. N_c is the number of C atoms in the alkyl chain. Dashed lines represent fits to straight lines.

whose intercalation chemistry has been discussed in detail by Lagaly (1979). However, the strong acidity of the silicate layers in these compounds ($\text{p}K_s < 3$) allows the intercalation of a variety of bases such as pyridine, quinoline, and DMSO, which are not intercalated by krautite.

Structure

Methylammonium krautite; $N_c = 1$. Figure 6 shows that the inter-layer spacing of methylammonium krautite falls significantly below the straight line that can be drawn through the other points with N_c an odd number.

Reynolds (1980) has described how random interstratification may cause extra reflections to occur in the powder X-ray diffraction profiles of clays with incompletely filled interlayers. These are observed between the basal reflection for an unreacted portion and the basal reflection for a fully reacted portion of sample. The intensities of the extra peaks depend on the angular 2θ separation of the two peaks. If they are more than $3^\circ 2\theta$ apart, no extra reflections are usually observed. A further effect may be the reduction of the d value of the basal reflection for the fully intercalated portion of the sample.

An examination of Table 1 reveals that this methylamine-reacted sample is only 31% intercalated. Hence, the presence of an unindexed peak ($d = 8.7 \text{ \AA}$) between the basal reflection from the fully reacted portion and that from the unreacted portion would appear to indicate that the observed reduction in d value is due to random interstratification. In this compound approximately one third of the interlayers contain methylamine.

An alternative analysis of these results is that the reduction in d value is caused by the keying-in of the H

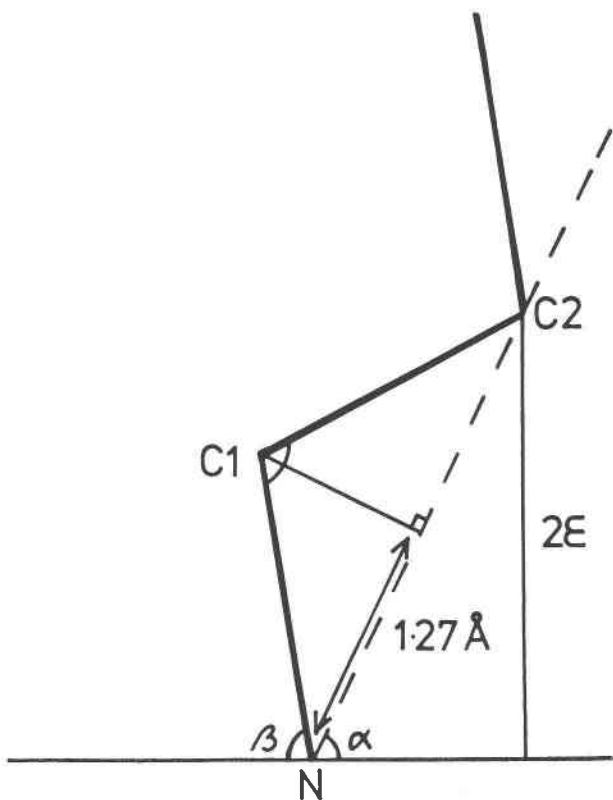

Fig. 7. Tilting of alkylammonium ions in krautite-alkylamine compounds.

atoms of the methylammonium groups into voids coordinated by O on the surfaces of the manganese-arsenate layers (i.e., into the centroid of the triangle formed by three O or OH moieties on the surface of the close-packed sheet). Roland and Weiss (1963) have described a model whereby the H atoms of a methylamine molecule intercalated into a silicate may penetrate the silicate surface by as much as 0.7 Å if positioned over a void coordinated by O.

Odd-even alternation; $N_c \leq 8$. Table 2 shows the variation of the basal spacings, d_{020} , of the krautite-alkylamine complexes with the length of C chain, N_c , of the alkylamine. By calculating the differences between consecutive basal spacings from $N_c = 3$ to $N_c = 8$, the mean increase of the basal spacings $\Delta d_{020}/\Delta N_c$ may be obtained. This was found to be 1.96 Å, which is in close agreement with the value of 1.93 Å obtained by Beneke and Lagaly (1981). If the alkyl chains were arranged in monolayers perpendicular to the inorganic layers, the value of $\Delta d_{020}/\Delta N_c$, from the geometry of the C chain would be approximately 1.27 Å. Since, in fact, the mean increase of the basal spacings is 1.96 Å, the alkyl chains must be arranged in bilayers tilted at an angle α to the basal plane (010). This analysis assumes a so-called *trans* configuration of the alkyl chain rather than a *cis* one with *gauche* bonds (i.e., a *cis* bond is the middle of a *trans*

alkyl chain), which is generally considered less likely (Weiss, 1963).

The interlayer structure of the alkylamines in krautite is similar to the structure of the neutral amine complexes of vermiculite and montmorillonite discussed by numerous authors (e.g., Brindley, 1965; Lagaly, 1986). In these systems there are two layers of fully extended alkylamine molecules inclined at about 65° to the basal plane. The NH₃ groups are thought to be closely associated with pairs of silicate oxygen atoms probably by H bonding.

Beneke and Lagaly (1981) reported that alkylamines increase the basal spacing of krautite linearly according to the relationship

$$d_{020} = 13.4 + 1.93N_c \text{ (Å)} \quad (1)$$

although they do not report any observed d values or give a plot of N_c vs. d_{020} for the complexes. However, Figure 6 shows that there is an odd-even alternation, with the mean increase from even to odd being 3.49 Å and that from odd to even being 1.41 Å. The pronounced alternation of the spacings for $2 < N_c < 9$ is typical for well-ordered, tilted chains (Weiss, 1963). The following relationships were obtained by calculating the best straight lines through the data for even (Eq. 2) and odd (Eq. 3) complexes by linear regression:

$$d_{020} = 8.58 + 2.36N_c \text{ (Å)} \quad (2)$$

$$d_{020} = 10.79 + 2.21N_c \text{ (Å)} \quad (3)$$

The average value of the gradients in Equations 2 and 3 is equal to the mean increase in d_{020} per C atom. Half the average value of the gradients in Equations 2 and 3 is equal to the mean increase in the projection of the alkyl chain length on to the b axis (ϵ), i.e., 1.14 Å. For alkyl chains arranged parallel to the b axis, no odd-even alternation would be observed, and a consideration of bond lengths and geometry shows that ϵ would then be equal to 1.27 Å. In Figure 7 it can be seen that an angle of tilt, α , may be defined such that $\sin \alpha = \epsilon/1.27$. Therefore, in the present case, $\alpha = 64^\circ$. The angle β is, from simple geometry assuming tetrahedral bond angles, $144.8 - \alpha \sim 81^\circ$. The error on these estimated angles is about 9°. It is noteworthy that β is within one standard deviation of 90°. At this angle alkyl chains with all *gauche* bonds give the same d value as those with all *trans* bonds. If $\alpha > 55^\circ$, the structure must be all *trans*. However, our data are not sufficiently precise to distinguish between these two possibilities.

The observed odd-even alternation has interesting consequences for the interpretation of the bonding in intercalated krautite. Beneke and Lagaly (1981) argued that only one H bond is formed from an intercalated alkylamine to the surface O atoms. This would require the N-H bond of the amine group to point approximately vertically toward the surface. Figure 8a shows that this orientation causes an odd-even alternation, where the increase from N_c odd to N_c even is greater than the increase from N_c even to N_c odd. However, in the krautite-alkylamine complexes described here, the opposite is observed.

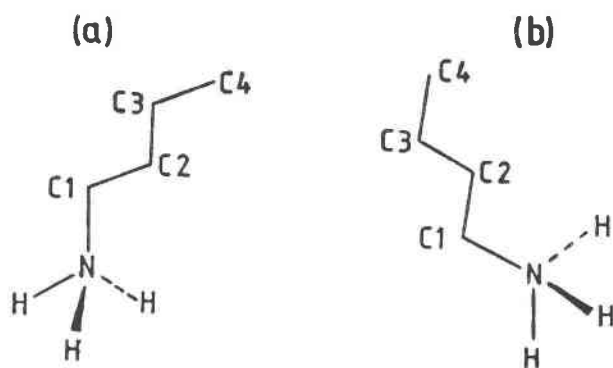

Fig. 8. Possible orientations of alkylammonium ions in krautite (a) N-C₁ vertical, (b) N-H vertical.

As shown above, the N-C₁ bond is approximately normal to the basal plane at an angle of $\beta \sim 81(9)^\circ$ (Fig. 8b). The argument of Beneke and Lagaly is based on an analogy with silicate surfaces, where amine groups may be attached by two or even three H bonds to two or three surface O atoms. This requires distinct distances between the surface O atoms ($\sim 5 \text{ \AA}$), which in oxygen close-packed silicates are arranged in hexagonal arrays. Beneke and Lagaly considered that the arrangement of the O atoms on the surface of the krautite sheets would permit the bonding of only one H from the NH₃ group. However the d -value results described above, and in particular the observation that the N-C₁ bond is almost normal to the inorganic layer, suggest that up to three H bonds may be formed.

A consideration of the layer-surface O atoms of krautite reveals that there are pairs of O atoms at suitable distances apart (5.26 \AA and 5.28 \AA), which allow H bonding between two H atoms of an NH₃ group and at least two surface O atoms (Fig. 9). From the symmetry of the structure, there are at least eight of these possible sites for H bonding in one unit cell of krautite, which is consistent with the intercalation of eight alkylamines per unit cell, i.e., one per HMnAsO₄·H₂O.

Interstratification and kink structures. Figure 5C shows that for the $N_c = 5$ intercalated sample there are extra reflections observed between the unreacted krautite basal reflection ($d = 7.98 \text{ \AA}$) and the basal reflection for fully intercalated $N_c = 5$ krautite ($d = 21.7 \text{ \AA}$). This behavior is also exhibited in the $N_c = 9$ and $N_c = 10$ samples. In all these samples the extent of reaction is less than 0.43 (Table 1).

Reynolds (1980) describes how these extra reflections may be attributed to interstratification, which may also cause a reduction in the d value of the basal reflection from a fully intercalated portion. In Figure 6 it is seen that for $N_c > 8$, the basal spacings do not lie along the straight lines predicted for N_c odd or N_c even. The basal spacings continue to increase, but not by the increments expected for bilayers oriented similarly to the alkylamines with $N_c < 9$. However, it is seen that sample $N_c =$

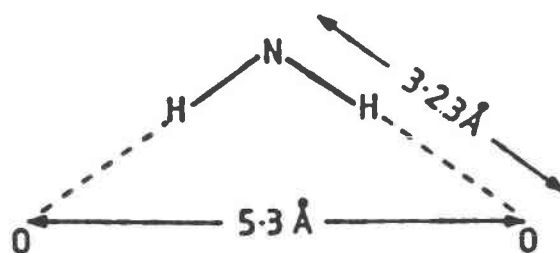

Fig. 9. Possible H bonding between alkylammonium groups and two surface O atoms of krautite.

5 does fall along the N_c odd line. The success of the geometrical model in predicting the d values for the samples with $N_c = 3$ to 8, despite some evidence for interstratification, suggests that the departures observed in samples $N_c = 9$ and $N_c = 10$ may be attributed to geometrical factors. Lagaly (1976) observed that absorption of alkanols into alkylammonium-montmorillonite decreased the basal spacings because of the formation of gauche-block structures between the silicate layers. That is, the alkyl chains became kinked rather than fully extended (Fig. 10a).

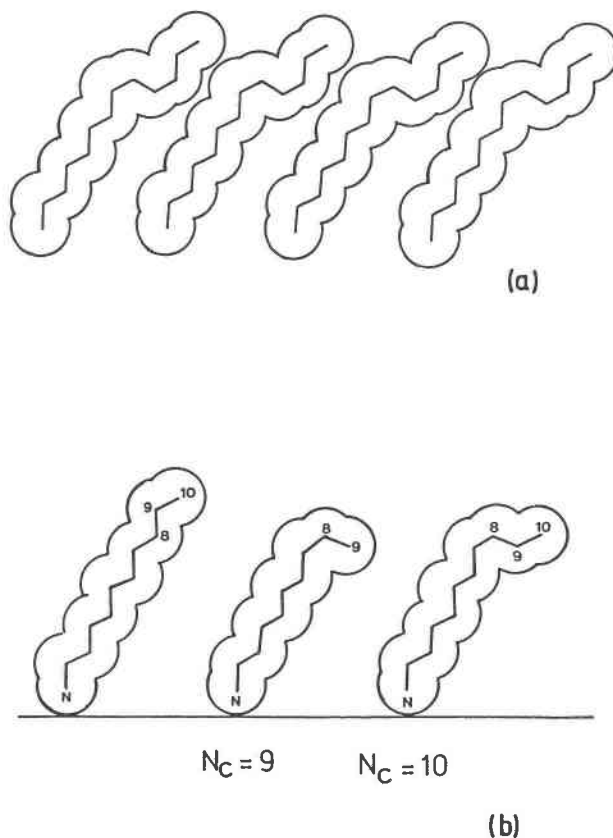

Fig. 10. (a) Formation of kink structures in alkyl chains. (b) Shortening of an alkyl chain by a gauche bond.

Extensive studies with nonsiliceous host materials (e.g., titanates, niobates, molybdates, and uranates) have revealed that gauche-block structures are more common than originally assumed. The complexes $N_c = 9$ and $N_c = 10$ in the krautite series are shortened by ~ 3.2 Å. If it is assumed that the bond angles are tetrahedral and that the angle of tilt α is 55° , it is simple to demonstrate that for the compound $N_c = 9$, a kink at the 8th C in the alkyl chain will shorten the d value by ~ 3.1 Å (for bilayers; Figure 10b), which is close to the observed decrease of 3.2 Å. For a kink at any other C atom the reduction would be at least 5.6 Å. For the compound $N_c = 10$, no simple kink structures can cause the value of $d(N_c = 10)$ to be greater than $d(N_c = 8)$. It is possible that the angle of tilt, α , changes in this kink structure, or that there is an interpenetration of the alkyl chains as occurs in alkylammonium micas (Walker, 1967).

A decrease in basal spacing in the manner observed here can only occur if most of the chains cooperate in the conformational changes. The kinks cannot be formed at random positions within the chains, and the probability of their formation is high at positions at which the formation of a kink fits the chain to neighboring chains. They are particularly favored when the host materials contain puckered layers. The flexibility of the monolayers or bilayers of alkyl chains with gauche structures allows a better fit onto the surface of the host layers. Kinks have also been observed in the intercalation compounds of primary diamines with the layered oxide HTiNbO₅ (Grandin et al., 1985).

The formation of kink structures could also explain the rather low extent of reaction of the alkylamines having $N_c > 8$ with krautite, as illustrated by the analytical results in Table 1. Kink structures would require a greater surface area between the krautite sheets, since they are not close packed and fewer molecules may be accommodated therein. However, the observed basal spacings still require the formation of bilayers.

ACKNOWLEDGMENTS

We would like to thank W.N.E. Meredith and J. Booth from I.C.I. Chemicals and Polymers Ltd., Runcorn, for the scanning electron micrographs and interesting discussions. A.M.B. thanks I.C.I. Chemicals and Polymers Ltd. and Balliol College, Oxford, for financial assistance. S.T.B. thanks Lincoln College, Oxford, for an E.P.A. Cephalosporin Junior Research Fellowship.

REFERENCES CITED

- Beneke, K., and Lagaly, G. (1981) Krautite, MnHAsO₄·H₂O: An intracrystalline reactive mineral. *American Mineralogist*, 66, 432–435.
- Bramwell, S.T., Buckley, A.M., Visser, D., and Day, P. (1988) Magnetic susceptibility study of KNiAsO₄, HMnAsO₄·H₂O and their organic-intercalated derivatives. *Physics and Chemistry of Minerals*, 15, 465–469.
- Brindley, G.W. (1965) Clay-organic studies X. Complexes of primary amines with montmorillonite and vermiculite. *Clay Minerals*, 6, 91–96.
- Buckley, A.M. (1988) Inorganic-organic layer compounds: syntheses and properties. Ph.D. thesis, Oxford.
- Catti, M., and Franchini-Angela, M. (1979) Krautite, Mn(H₂O)(AsO₃OH): Crystal structure, hydrogen bonding, and relations with haidingerite and pharmacolite. *American Mineralogist*, 64, 1248–1254.
- Catti, M., Chiari, G., and Ferraris, G. (1980) Fluckite, CaMn(HAsO₄)₂·H₂O, a structure related to krautite HMnAsO₄·H₂O. *Bulletin de Minéralogie*, 103, 129–134.
- Ferraris, G. (1969) The structure of pharmacolite, CaHAsO₄·H₂O. *Acta Crystallographica*, B25, 1544–1550.
- Ferraris, G., Jones, D.W., and Yerkess, J. (1972) Neutron and X-ray refinement of the crystal structure of CaHAsO₄·H₂O. *Acta Crystallographica*, B28, 209–214.
- Fontan, F., Orliac, M., and Permingeat, F. (1975) La krautite, HMnAsO₄·H₂O, une nouvelle espèce minérale. *Bulletin de la société française de minéralogie et de cristallographie*, 98, 78–84.
- Grandin, A., Borel, M.M., and Raveau, B. (1985) Intercalation of primary diamines and amino acids in the layer structure HTiNbO₅. *Journal of Solid State Chemistry*, 60, 366–375.
- Lagaly, G. (1976) Kink-block and gauche-block structures of bimolecular films. *Angewandte Chemie International Edition in English*, 15, 575–586.
- (1979) Crystalline silicic acids and their interface reactions. *Advances in Colloid and Interface Science*, 11, 105–148.
- (1986) Interaction of alkylamines with different types of layered compounds. *Solid State Ionics*, 22, 43–51.
- Reynolds, R.C. (1980) Interstratified clay minerals. In G.W. Brindley and G. Brown, Eds., *Crystal structures of clay minerals and their X-ray diffraction identification*, p. 249–303, Mineralogical Society Monograph No. 5. Mineralogical Society, London.
- Roland, R.A., and Weiss, E.J. (1963) Bentonite-methylamine complexes. *Clays and Clay Minerals*, 10, 460–468.
- Walker, G.F. (1967) Interactions of n-alkylammonium ions with mica-type layer lattices. *Clay Minerals*, 7, 129–143.
- Weiss, A. (1963) Mica-type layer silicates with alkylammonium ions. *Clays and Clay Minerals*, 12, 191–224.
- Zettler, F., Riffel, H., Hess, H., and Keller, P. (1979) Cobalt (II) hydrogen arsenate monohydrate. Preparation and crystal structure. *Zeitschrift für Anorganische und Allgemeine Chemie*, 454, 134–144.

MANUSCRIPT RECEIVED JULY 6, 1989

MANUSCRIPT ACCEPTED JUNE 29, 1990