

MUSCOVITE WITH SMALL OPTIC AXIAL ANGLE*

J. M. AXELROD AND F. S. GRIMALDI,
U. S. Geological Survey, Washington, D. C.

CONTENTS

Abstract.....	559
Introduction.....	559
Occurrence.....	559
Related Studies.....	560
Description and Optical properties.....	561
Chemical composition.....	564
Thermal analysis.....	565
X-ray studies.....	565
Powder pattern.....	565
Laue photographs.....	566
Rotation and Weissenberg photographs.....	566
Summary.....	572
Acknowledgments.....	572

ABSTRACT

Muscovite with unusual optical and structural characteristics is described. The size of the optic axial angle ($2V$) varies from about 15° for areas of highest birefringence in the cleavage plane to about 3° for areas of lowest birefringence. X-ray studies show the muscovite to be three layered monoclinic with $Z=a$ and thus dimorphous with previously described muscovites. Variation in the observed optic axial angle is attributed to the coalescence of the optical effects of superposed twin elements.

INTRODUCTION

In the course of field investigations near the Sunrise Copper Prospect, Sultan Basin, Snohomish County, Washington, J. J. Collins collected a white mica that was later identified as a muscovite with very unusual optical and structural characteristics. C. S. Ross found it to be nearly uniaxial and suggested further study of the material.

OCCURRENCE

A. C. Waters collected additional material and made a brief examination of the field relations. His description follows:

"A white, nearly uniaxial muscovite occurs as veinlets and replacements in the granodiorite near the Sunrise Copper Prospect, Sultan Basin, Snohomish County, Washington. The mica occurs as both fissure and 'replacement veins' $\frac{1}{4}$ to 1 inch thick which commonly appear along closely spaced partings or sheeting in the granodiorite. In part the mica appears to have been formed by selective replacement of the granodiorite, for, although at some localities the position of the feldspars is occupied by mica, the original quartz grains

* Published by permission of the Director, U. S. Geological Survey.

are intact. Hot gases, following the sheeting in the granite rock, probably were the agents that formed the mica. The process probably is similar to greisenization.

"The mode of occurrence of the mica bears a striking resemblance to the occurrence of siderophyllite in 'replacement veins' in the Tertiary granite of the Mourne mountains in Northern Ireland, described by Nockolds and Richey.¹ The field relations and general appearance of the veinlets at the Sunrise Prospect are similar to those in the Mournes."

RELATED STUDIES

Muscovites with small optic axial angles have been reported in the literature, but they are rare. Carl Schmidt² found, in a gneiss from the Adula Mountains, Switzerland, a green pleochroic muscovite that was uniaxial. It became biaxial on heating and on cooling became uniaxial again. Kunitz³ reported a uniaxial muscovite in mica schist from Mt. Muchrone. After the ignition of the mica flakes Kunitz could detect no substantial change in the size of the optic axial angle. Recently Postel and Adelhelm⁴ described a white muscovite in the Wissahickon formation with low values of $2V$ varying between 22° and 50° . Laue photographs of the mica showed radial diffuseness or "asterism," and Postel and Adelhelm suggested that the degree of radial diffuseness might be connected with the low and varying values of $2V$ observed on the mica.

A detailed analysis of the structure of muscovite was made by Jackson and West.⁵ Hendricks⁶ has shown that the structure of other micas is more complex, and that most of them are polymorphic, the polymorphism resulting from different arrangements of the layers. Hendricks found no polymorphism in muscovite; all 19 studied specimens had the same two-layer monoclinic structure. In every specimen the optic axial angle ($2V$) was between 34° and 50° , and the plane of the optic axes was normal to the b axis. He found that the distinguishing feature of the muscovite structure is a distortion from the ideal structure shown by the presence of certain reflections absent for the ideal structure. This distortion results from the incomplete filling of the octahedral positions

¹ Nockolds, S. R., and Richey, J. E., Replacement veins in the Mourne Mountains granites: *Am. Jour. Sci.*, **237**, 27-47 (1939).

² Schmidt, C., Die Gesteine des Adulamassivs: *Beitr. Geol. Karte Schweiz, Anhang Lief.*, **25**, 32 (1891).

³ Kunitz, W., Die Beziehungen zwischen der chemischen Zusammensetzung und den physikalisch-optischen Eigenschaften innerhalb der Glimmergruppe: *Neues Jahrb., Beilage-Band*, **50**, 383 (1924).

⁴ Postel, A. W., and Adelhelm, W., White mica in the Wissahickon complex: *Am. Mineral.*, **29**, 279-290 (1944).

⁵ Jackson, W. W., and West, J., The crystal structure of muscovite: *Zeit. Kryst. Min.*, **76**, 211-227 (1930).

Jackson, W. W., and West, J., The crystal structure of muscovite: *Zeit. Kryst. Min.*, **85**, 160-164 (1933).

⁶ Hendricks, S. B., and Jefferson, M. E., Polymorphism of the micas: *Am. Mineral.*, **24**, 729-771 (1939).

and was considered by Hendricks to be the factor leading to a unique requirement on the successive stacking of layers.

For many of the micas Hendricks found appreciable diffuse scattering in Weissenberg photographs along (h_0k_0l) , $k \neq 3n$ curves. This showed up as radial streaks in Laue photographs of the micas taken with the incident x -ray beam normal to the cleavage plane. Both were explained in terms of constant h and k indices with continuous variation of the l index resulting from a variable periodicity in the stacking of the mica layers in such a manner that planes with the k index a multiple of three were apparently undisturbed. He did not find diffuse scattering for any muscovite.

Asterism was encountered by Postel and Adelhelm in Laue patterns of muscovite and the Sultan Basin muscovite exhibits similar radial diffuseness. H. C. Vacher⁷ observed that permanent asterism could be developed or increased in micas by heating biotite or phlogopite to about 500° C. or muscovite to 800° C. The asterism developed in phlogopite at 190° to 385° mostly disappeared on cooling.

DESCRIPTION AND OPTICAL PROPERTIES

The mica from Sultan Basin consists of wedge-shaped aggregates of trowel-shaped crystal segments. The segments, about $4 \times 3 \times \frac{1}{2}$ millimeters in size, are ruled parallel to the directions AC and AD of Fig. 1(a), and much of the surface is ribbed or corrugated parallel to these rulings. There is a slight bending along AB (variable from crystal to crystal) so that the mica flakes do not lie completely flat on a slide. The segments cleave into thin elastic laminae that often split along the rulings to form narrow strips. These rulings, by analogy with muscovite in general, correspond to traces of glide planes or to pressure lines.

Under crossed nicols the flakes are seen to be twinned and AB in Fig. 1(a) may be taken as the trace of the composition plane. AB appears only under crossed nicols and as a narrow region of low birefringence. It is presumably the result of intergrowth or superposition of twins in the area as this region is almost uniaxial ($2V = 3^\circ$). The twinning is repeated in a few crystals so that if extended further it would give forms with pseudo-hexagonal symmetry. The direction of the optic axial plane in each half of the flake and in the region AB is shown in Fig. 1(a). In the twins it is parallel to RS and RT and the direction is invariant over the whole of each twin. The relative orientation of the rulings and the axial plane indicate that $Z = a$ and the mica is in the second class of Reusch⁸ used by

⁷ Vacher, H. C., in Hidnert, P., and Dickson, G., Some physical properties of mica: *Jour. Research, Nat. Bur. Standards*, **35**, 339-342 (1945).

⁸ Reusch, E., Über die Kornerprobe am zweiachsigen Glimmer: *K. Akad. Wiss., Berlin, Monatsberichte*, 429 (1868).

Dana.⁹ The twinning axis for the common mica twin law is $[310]$ which, for $Z = a$, is normal to AB , and in the cleavage plane. A rotation of 180° about the twin axis gives an apparent rotation of the axial plane in the

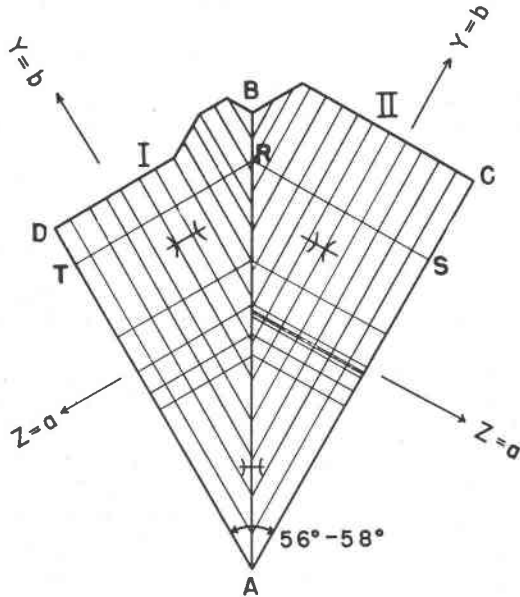

FIG. 1(a). Optical orientation.

cleavage plane of 60° . Part I is therefore related to Part II by the common mica twin law; the composition surface is normal to the twinning axis.

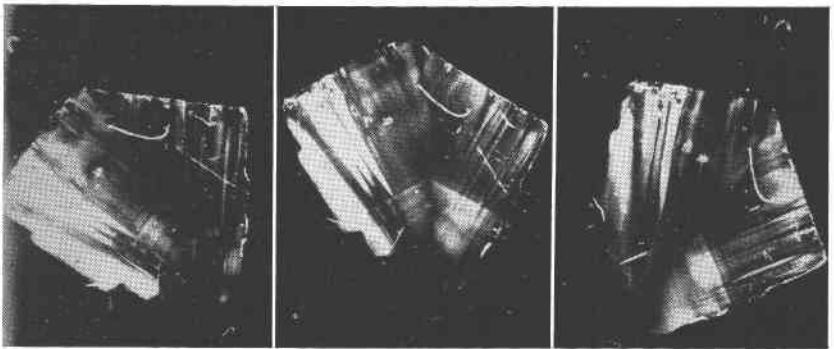

FIG. 1(b). Photomicrographs with crossed nicols.

⁹ Dana, E. S., and Ford, W. E., *A Textbook of Mineralogy*, 4th ed., p. 658 (1932).

Striations parallel to *RS* and *RT* appear under both uncrossed and crossed nicols. They are faint under uncrossed nicols and may be due to the slight differences in index of refraction. Under crossed nicols these striations, for the most part, are sharp and appear as bands of lower and higher birefringence. Striations parallel to *AC* and *AD* are due to bends and cracks in the crystal. No spot could be found on a dark streak parallel to *AC* or *AD* which did not at some point in the rotation of the flake between crossed nicols become as bright as the rest of the band parallel to *RS* or *RT* in which it lay. The size of the optic axial angle ($2V$) for the bands of lower birefringence is always smaller than 15° , the value approached by the bright areas, and varies from area to area. The lower the birefringence the smaller $2V$ becomes; it is 3° for areas of lowest birefringence. In these regions the isogyres are also more diffuse.

Any explanation of the variation based on twinning such that the orientation of the cleavage plane would be changed is ruled out, because any such regions with the cleavage plane not perpendicular to the light path would show a higher instead of a lower birefringence. The low $2V$ may, however, be a result of superposition of twins such as occurs at *AB*. The net result is as if equal amounts of I and II were rotated clockwise 60° and made to interleave with I, or rotated counterclockwise 60° and made to interleave with II. The combination would consist of equal thicknesses of mica superimposed at all angle multiples of 60° and may be formed by repeated twinning according to the mica law with composition plane (001). It would be essentially the same as one of the combinations mechanically built by Reusch¹⁰ which he describes as giving an almost perfect uniaxial figure. The varying size of $2V$ would then result from combinations of the rotated members with varying amounts of the unrotated twin I or II. The bands of lower and higher birefringence require additional composition planes approximately parallel to (010).

From another viewpoint, the mica has a different crystal structure in the regions showing a smaller optic angle. Only two structures need be involved to produce all the effects described, as varying amounts of the two structures combined in parallel orientation would give the various differences in the size of the optic axial angle. X-ray work described in a following section did not reveal any definite structural difference so that the first explanation is taken as the more probable one.

The optical properties of the muscovite from Sultan Basin were measured in white light on portions of flakes showing maximum birefringence in the cleavage plane.

¹⁰ Reusch, E., Untersuchung über Glimmercombinationen: *Poggendorff's Annalen*, **138**, 628-638 (1869).

Biaxial negative: $\alpha = 1.555 \pm .003$ $2V = 15^\circ \pm 3^\circ$
 $\beta = 1.589 \pm .003$ $Z = a$
 $\gamma = 1.590 \pm .003$

Pleochroism feeble: X = pale yellow with some green,
 Y = Z = deeper yellow with more green.

The α index was measured on several small cleavage plates of mica standing on edge in flour dough with their protruding ends immersed in index oil. The values of the indices are somewhat uncertain because of the corrugated nature of the material, but are sufficiently accurate to establish that the maximum birefringence is the same as in the more common muscovite. The values of β and γ agree closely with Winchell's¹¹ data on the muscovite system.

CHEMICAL COMPOSITION

The chemical analysis of the mica from Sultan Basin is given in Table 1. The calculation of the atomic ratios was made by the method devised

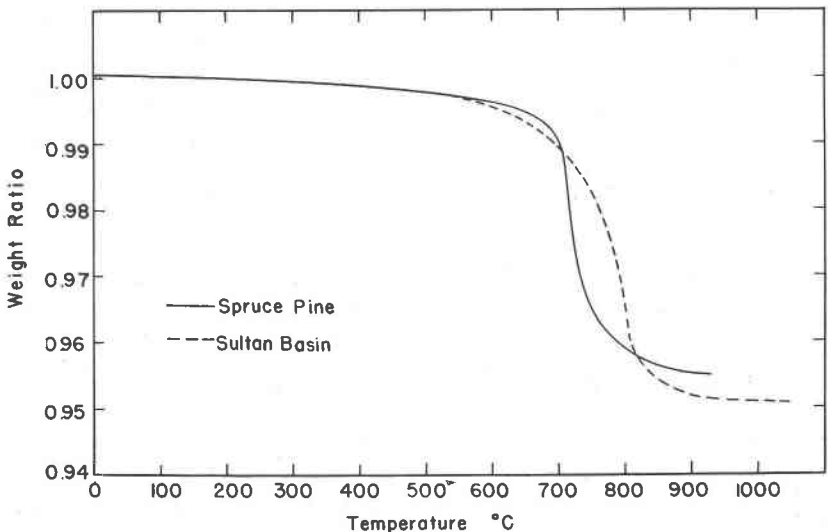

FIG. 2. Thermal dehydration curves.

by Stevens^{12,13} on the basis of 22 anion and cation equivalents in the simple mica formula. The formula obtained is that of muscovite.

¹¹ Winchell, A. N., *Elements of Optical Mineralogy*, Part II, p. 268 (1933).

¹² Stevens, R. E., *New analyses of lepidolites and their interpretation: Am. Mineral.*, **23**, 607-628 (1938).

¹³ Stevens, R. E., *A system for calculating analyses of micas and related minerals to end members: U. S. Geol. Survey, Bull.* **950**, 101-119 (1946).

TABLE 1. ANALYSIS OF THE MICA FROM SULTAN BASIN,
SNOHOMISH COUNTY, WASHINGTON

		Equivalents		Atomic Ratios	
		<i>e</i>	<i>e'</i> = 3.993 <i>e</i>		
SiO ₂	46.77	3.113	12.43	Si	3.11
				Al	.89
				Σ Tetrahedral	4.00
Al ₂ O ₃	34.75	2.044	8.16	Al	1.83
Fe ₂ O ₃	.71	.028	.11	Fe+++	.04
FeO	.77	.021	.08	Fe++	.04
MgO	.92	.046	.18	Mg	.09
TiO ₂	.21	.011	.04	Ti	.01
				Σ Octahedral	2.01
CaO	.13	.005	.02	Ca	.01
Na ₂ O	.47	.015	.06	Na	.06
K ₂ O	10.61	.225	.90	K	.90
BaO	.13	.002	.01	Ba	.01
		5.509	21.99	Σ Large Cation	0.98
F	.16	.008	.03	F	.03
Total H ₂ O	4.48	.497	1.98	OH	1.98
	100.11			F+OH	2.01
Less O=F	.07		Formula:		
Total	100.04		(KNaCaBa) _{0.98} (AlFe''Fe''' MgTi) _{2.01}		
Specific Gravity	2.82		(SiAl) _{4.00} O _{10.01} (F, OH) _{2.01}		

Spectrographic examination by K. J. Murata showed, as the only other constituents: Li₂O=0.02, and Rb₂O=0.05.

THERMAL ANALYSIS

P. G. Nutting determined the thermal dehydration curves of the muscovite from Sultan Basin and of a muscovite from Spruce Pine (*Am. Mineral.*, **27**, 527, 1942; *Am. Mineral.*, **24**, 759, 1939). The latter represents a common muscovite. The results are plotted in Fig. 2. The muscovite from Sultan Basin gives off the last of its water at a slightly higher temperature (about 50°) than does the muscovite from Spruce Pine, but this is within the limits of variation for muscovite.

X-RAY STUDIES

Powder patterns

The powder pattern of the mica had only minor differences from the patterns of muscovites from eleven other localities. The patterns of the

eleven other muscovites were identical, the pattern of the muscovite from Sultan Basin differing from them in that it had no lines at 2.99 Å, 3.20 Å, 3.49 Å, and 4.12 Å, and a stronger line at 3.10 Å. Fig. 3 illustrates the two patterns and the measurements are given in Table 2.

Laue Photographs

Laue photographs with the beam perpendicular to the cleavage plane were taken in an attempt to determine the symmetry of the muscovite from Sultan Basin and to detect structural differences between areas with large $2V$ and areas with small $2V$. Over 20 specimens were carefully cut out from areas showing a minimum of warping. When mounted on a two-circle goniometer for orientation they gave poor signals indicating that they were warped. Unavoidable small variations from the nominal orientation caused more difference in the appearance of the Laue patterns in regard to intensities and positions of spots than any structural differences among the samples, and therefore no reliance was placed on Laue patterns for symmetry determination. All patterns were, however, approximately trigonal and all showed some asterism. Fig. 4 (b) illustrates a typical Laue pattern. Fig. 4 (a) and 4 (c) were taken using the same flake and illustrate effects produced when the X-ray beam is not perpendicular to the cleavage plate. The latter are shown to indicate some of the changes that warping could produce.

Rotation and Weissenberg Photographs

Rotation pictures about the normal to the cleavage plane had layer lines corresponding to a 30 Å spacing. Inasmuch as the thickness of a mica sheet is 10 Å, the muscovite from Sultan Basin has a unit cell three layers high. This is the first muscovite for which a unit cell other than two layers high has been found.

Weissenberg photographs were then used with some success to study the symmetry of the muscovite from Sultan Basin. An area with a small optic axial angle ($2V=3^\circ$) was first chosen and because of the three-layered structure, we looked first for rhombohedral symmetry. Weissenberg photographs were taken rotating the crystal fragment about $[010]$, $[110]$, $[310]$, $[100]$, $[3\bar{1}0]$, and $[\bar{1}10]$ on the basis of $Z=a$ and a monoclinic cell. If the crystal were trigonal the patterns for $[110]$, $[\bar{1}10]$, and $[100]$ should be identical as also the patterns for $[310]$, $[010]$, and $[310]$. Examination of the patterns revealed that $[110]$ and $[\bar{1}10]$ were identical while $[100]$ differed slightly only with respect to diffuseness in the $(h_a k_a l)$ zone lines. The same differences held for the b axis and pseudo b axis pictures. Figure 5 illustrates Weissenberg photographs taken about $[110]$, $[\bar{1}10]$, and $[100]$. An area with $2V=13^\circ$, whose Laue pattern is

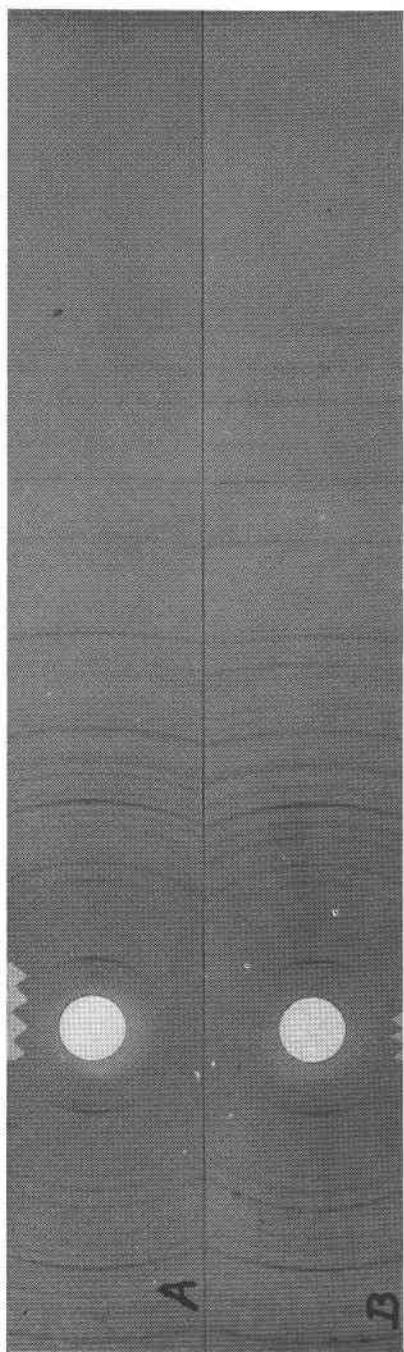

FIG. 3. X-ray powder photographs.
(A). Two layer muscovite from Keystone, S. D.
(B). Muscovite from Sultan Basin.

TABLE 2. X-RAY POWDER PATTERNS OF MUSCOVITE

Sultan Basin Fe radiation, unfiltered $\lambda=1.938\text{\AA}$		Common muscovites ASTM FILE, II 2177	
<i>d</i>	<i>I</i>	<i>d</i>	<i>I</i>
9.97	10	10.01	8
4.97	7	4.98	6
4.47	6	4.48	9
4.29	1	4.30	4
		4.12	4
		3.96	2
3.86	4	3.88	4
3.68	6*	3.72	5
3.59	2	3.56	2
		3.49	5
3.32	10	3.33	9
		3.20	6
3.10	4	3.1	2
		2.99	6
2.87	6	2.87	5
2.82	4	2.78	5
2.58	4	2.58	4
2.55	7	2.56	10
2.49	4	2.49	4
2.45	4	2.46	4
2.38	4	2.38	6
2.34	2	2.31	4
2.24	1	2.24	4
2.19	4	2.20	3
2.13	6	2.13	6
2.05	1	2.05	2
1.997	8	1.99	8
1.960	4	1.95	4
1.819	2	1.82	2
1.723	4	1.76	4
1.650	6	1.65	7
1.606	2	1.60	4
1.516	4		
1.500	6		
1.426	2		
1.347	6		
1.296	4		
1.248	6		
1.222	2		
1.053	4		

* At least partly β radiation from 3.32.

illustrated in Fig. 4 (b), was also checked in this manner with similar results. No significant differences between corresponding Weissenberg patterns of areas with small $2V$ and large $2V$ could be detected. The

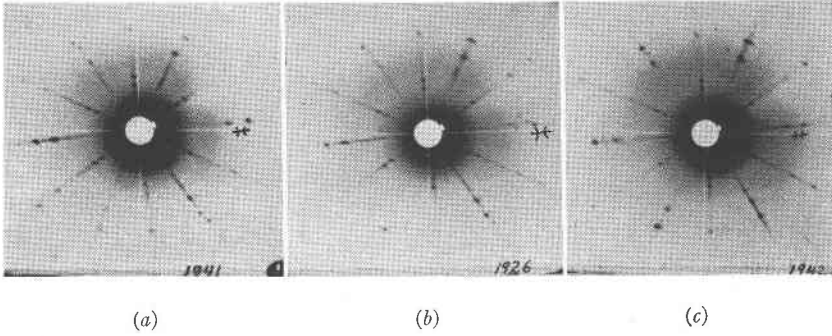

FIG. 4. Laue photographs.

- (a). Beam in the axial plane at 85° to the cleavage plane.
- (b). Beam normal to the cleavage plane.
- (c). Beam in the axial plane at 95° to the cleavage plane.

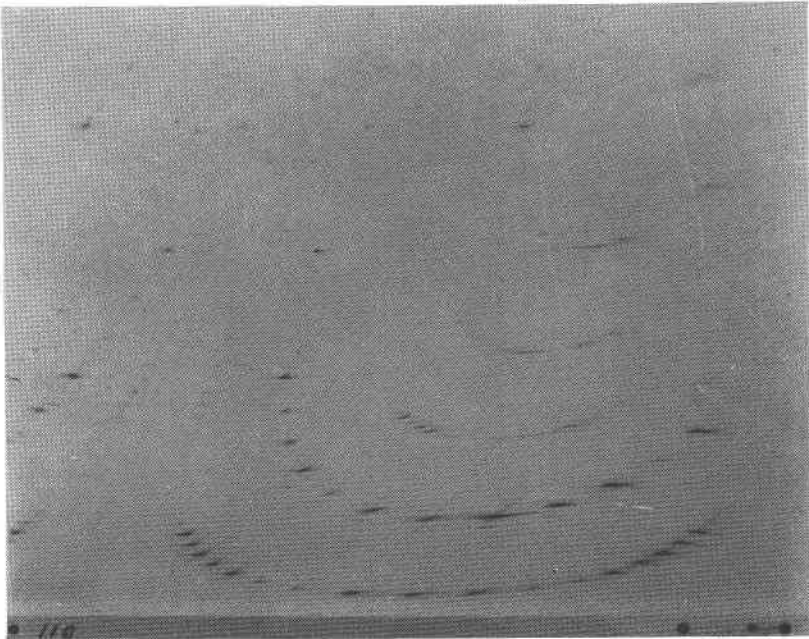

FIG. 5(a). First layer Weissenberg photograph.
Rotation about $[110]$ for area with $2V = 3^\circ$.

x -ray symmetry, based on the symmetry of the individual Weissenberg patterns, was C_{2h} or D_{3d} . If the differences in diffuseness between Weissenberg patterns are neglected, a threefold axis is demonstrated and the Laue symmetry is D_{3d} . If, as we prefer, the optic axial angle of 12° is not ascribed to strain and the differences in diffuseness are not neglected, the Laue symmetry must be taken as C_{2h} with the structure very close to trigonal.

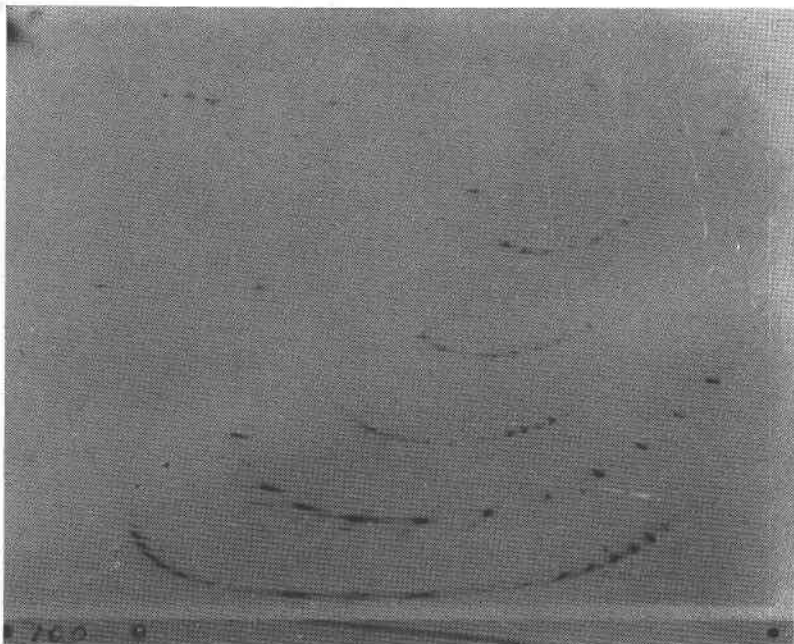

FIG. 5(b). First layer Weissenberg photograph.
Rotation about $[100]$ for area with $2V=3^\circ$.

If β is exactly 90° and the lattices of single muscovite layers are exactly trigonal, Weissenberg pictures about $[hk0]$ of a muscovite crystal twinned on composition plane (001) would consist of patterns of the untwinned parts exactly superposed with no doubling or diffusing of spots and with no extra spot positions. The only effect of twinning on the pictures would be a superposition of spots and an averaging of the intensities so that dissimilarities between patterns around such axes at 120° to each other would be minimized and, with equal amounts of twins at all 60° angles, dissimilarities would be eliminated. Actually the differences found in the Weissenberg photographs made at angles of 60° were very slight for

fragments with larger $2V$ as well as with small $2V$. The amount of diffuseness along $(h_a k_a l)$ curves was small compared to that shown by some micas described by Hendricks. There was much more diffuseness not along $(h_a k_a l)$ curves due to distortion (the corrugation) which appeared on the Weissenberg films mainly as streaks parallel to the rotation axis.

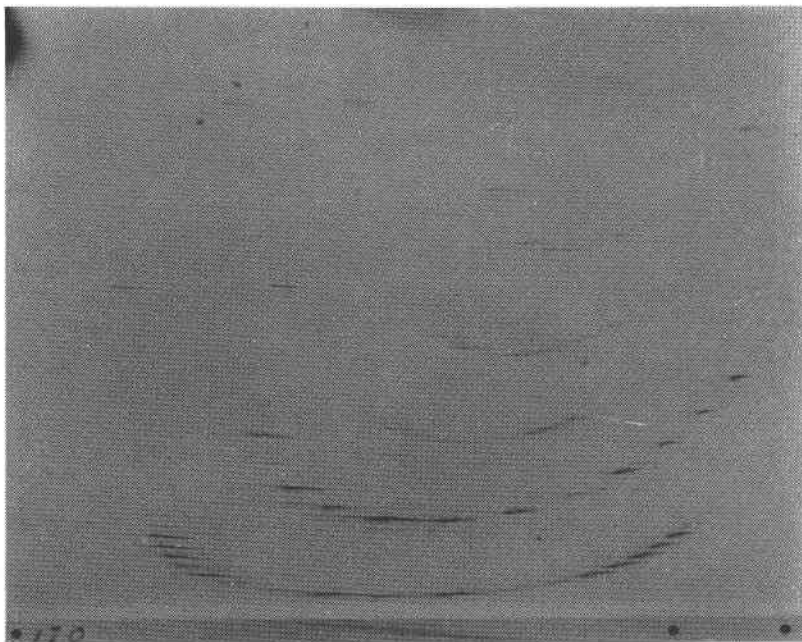

FIG. 5(c). First layer Weissenberg photograph.
Rotation about $[1\bar{1}0]$ for area with $2V=3^\circ$.

Such distortion or diffuseness would be evident in a Laue pattern as asterism and probably accounts for most of the asterism found on the Laue photographs.

Indexing of the patterns showed all reflections with $h+k$ odd were absent, $(00l)$ with $l \neq 3n$ was absent, and only a few weak reflections for $(h \cdot 3n \cdot l)$ with $h+l=3n$ were present. For a hexagonal description, these criteria would become: K is not a fraction; for $(00L)$, $L=3n$; and for $H+K=3n$, almost all $H+L=3n$; but they would not include that $H-K+L=3n$. Also the twofold axis is parallel to the shortest identity distance in the cleavage plane.

If the mica were described as trigonal, the cell dimensions would be the same as for the monoclinic description. The possible space groups

would be the enantiomorphic pair $D_3^3-C3_112$, and $D_3^5-C3_212$, the same as found by Hendricks for three-layered phlogopite and lepidolite.

For the monoclinic description there can be no threefold axis but the packing of layers may be described as simple translation of one layer with respect to the next, as from u, v, w , to $u+\frac{1}{3}, v+\frac{1}{3}, w+\frac{1}{3}$, to $u+\frac{2}{3}, v, w+\frac{2}{3}$, back to $u, v, w+1$. This would be equivalent to a threefold screw axis through $u+\frac{1}{3}, v+\frac{1}{3}$ for undistorted hexagonal mica sheets, and similarly preserves the twelvefold coordination of the potassium ions and the structure of the mica layers. The possible monoclinic space groups are C_3^3-Cm , C_2^3-C2 , and C_{2h}^3-C2/m . Only C_2^3-C2 is a subgroup of the possible trigonal space groups and is therefore taken as the most probable space group. The cell dimensions are:

$$\begin{aligned} a &= 5.20 \pm .01 \text{ \AA} \\ b &= 9.03 \pm .01 \text{ \AA} \\ c &= 30.04 \pm .03 \text{ \AA} \\ \beta &= 90^\circ \pm 10' \end{aligned}$$

SUMMARY

Muscovite shows the same type of polymorphism as the other micas. The muscovite from Sultan Basin has a three-layered monoclinic structure with a small degree of randomness in the packing of the layers and belongs to the mica group of the second class with $Z=a$. The optic axial angle is smaller than for the commoner two-layered muscovite and variable over a flake. The variation is explained as resulting from superposition or penetration of twins based on the common mica twin law.

ACKNOWLEDGMENTS

The writers are especially indebted to A. C. Waters who collected the sample for the study and furnished the description of the occurrence.

The writers thank K. J. Murata for the spectrographic work and P. G. Nutting for the thermal dehydration curves of the micas. The writers also thank C. S. Ross, W. T. Schaller, G. T. Faust, R. E. Stevens, and R. S. Cannon, Jr. for the many informal discussions in connection with this work.